

T, X & Y table

Design Tengbom, Daniel Lavonius Jarefeldt



Produktinformation

T, X & Y table är lättplacerade enkelbord med praktisk formgivning. Bord som lätt kan kombineras till olika sittmöbler och användas till flertalet arbetsätt.

På Y-table ger bordsskivans förskjutna placering bra åtkomst samt lyftmöjlighet.

Teknisk information

Borden tillverkas i vit högtryckslaminat, ekfanér, infärgad MDF samt betsad eller vitlaserad ask.

Skivmaterial i 12 mm björkplywood eller 16 mm infärgad MDF.

Metallstativ pulverlackeras.
Metallprofil är 20x20 mm för bordshöjd 50 & 60 cm och 25x25 för bordshöjd 72 cm.

Product information

T, X & Y table is easy-to-place-tables with practical design. Tables that can easily be combined with different seating and used for several working methods.

The displaced table top position of the Y table gives good access and lift possibility.

Technical information

The table top is produced in white high pressure laminate, oak veneer colored MDF and stained or white stained ash.

Table top is 12 mm birch plywood or 16 mm colored MDF.

Frame is powder coated.
Metal frame is 20x20 mm for table height 50 & 60 cm and 25x25 mm for table height 72 cm.

T, X & Y table

Design Tengbom, Daniel Lavonius Jarefeldt



T, X & Y table

Design Tengbom, Daniel Lavonius Jarefeldt

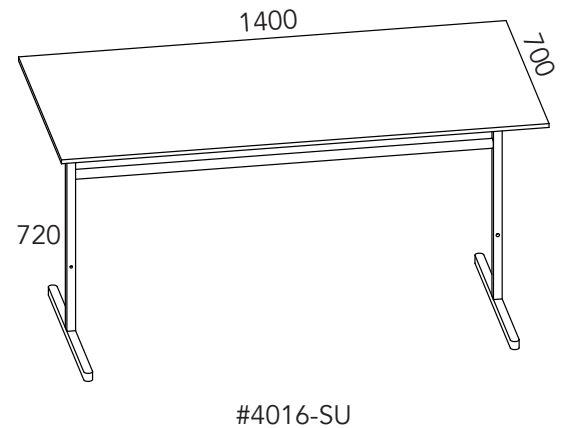
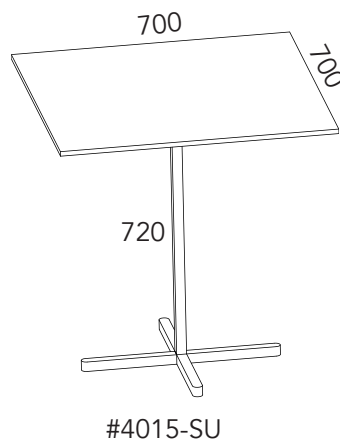
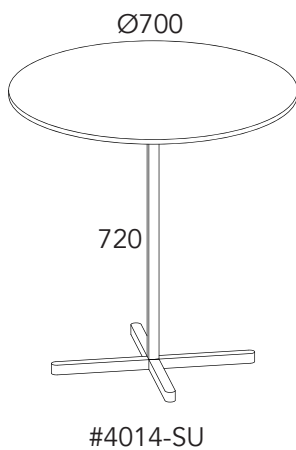
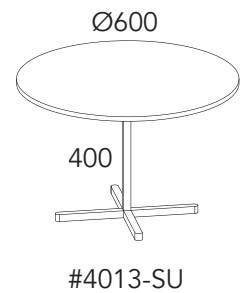
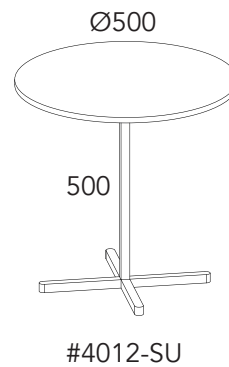
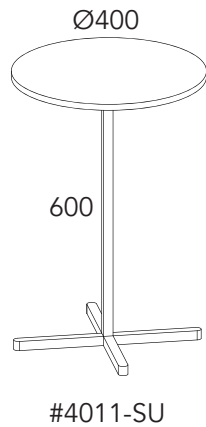
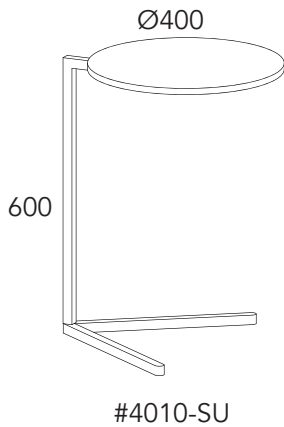

#=article number

Frame:



Black
RAL 9005

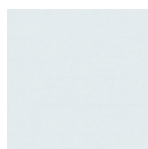

White
RAL 9016

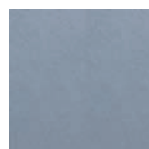

Silver grey
RAL 9006



Yellow
RAL 1005



Red
RAL 3000



Blue
RAL 5001



Green
RAL 6000

Table tops:

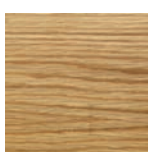

Oak veneer



White HP-laminate

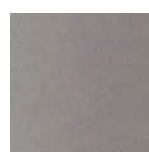

Light grey MDF

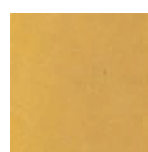

Yellow MDF



Red MDF

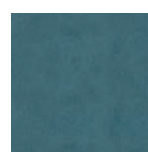

Blue MDF

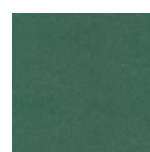

Green MDF

